

72" RCP PIPE DETAIL

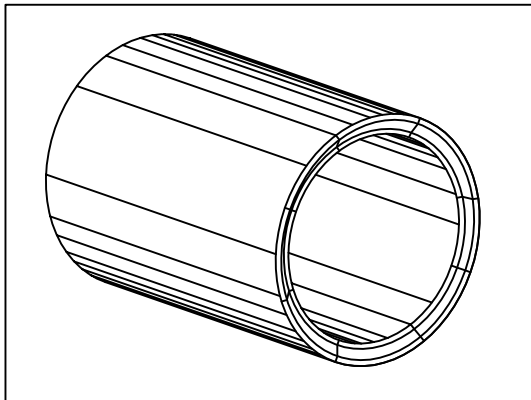

ISOMETRIC VIEW

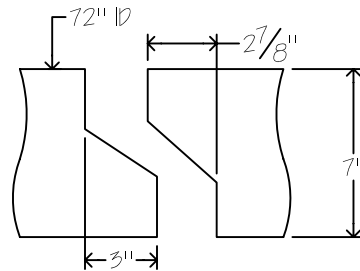

TONGUE AND GROOVE DETAIL

WEIGHTS:
 PER FOOT1811 LBS.
 8' LENGTH14488 LBS.
 4' LENGTH7244 LBS.

REVISIONS	BY

NOTES:

- 1) ALL DIMENSIONS SUBJECT TO ALLOWABLE SPECIFICATION TOLERANCES AND PARAMETERS.
- 2) STEEL REINFORCEMENT NOT SHOWN
- 3) PIPE IS MANUFACTURED PER ASTM C-76, AND CONFORMS TO SEC. 207-2 OF STANDARD SPECIFICATIONS FOR PUBLIC WORKS CONSTRUCTION.
- 4) IF USED, INTERNAL RUBBER GASKET SHALL CONFORM TO AASHTO DESIGNATION M-198-75

CONTRACT NO.		
DRAWN BY FVB		
CHECKED BY		
DATE 10/30/03		
P/N		
SHEET 1 OF	SCALE AS SHOWN	TITLE 72" RCP PIPE DETAIL